

WHEN QUALITY IS AN ISSUE,
THE CHOICE IS HAEFELY



IMPULSE VOLTAGE TEST SYSTEM
SGΔA
200-2600 kV, 10-260 kJ

SGΔA



**High Voltage
Test Business**

HAEFELY 
HIGH VOLTAGE TEST

IMPULSE VOLTAGE TEST SYSTEM

APPLICATION

SG Δ A impulse test systems are used to generate impulse voltages from 10 kV to 2400 kV simulating lightning strokes and switching surges. The total charging voltage range covers from 600 kV to 2600 kV with a stage energy of 5 or 10 kJ.

Haefely's system design and manufacture is based upon years of experience dating back to 1932. The SG Δ generators are flexible and cover testing applications according to IEC, ANSI/IEEE as well as other national standards.

The basic system can be upgraded in various ways for special tests and / or greater ease of operation. A number of additional circuits and components allow to optimise the impulse test system for tests on:

- power transformers
- cables (type tests)
- arresters (impulse current tests)
- motor / generators
- insulators
- bushings
- GIS
- instrument transformers

The user-friendly control unit can also be remotely operated from a host computer.

Due to its unique Haefely Δ -structure, the SG Δ impulse generator are perfectly suited for transportation and on-site erection.

Main features of the SG Δ A system are:

- total charging voltages from 600 kV up to 2600 kV
- 5 or 10 kJ stage energy
- lowest internal inductance ever achieved
- reliable and accurate triggering by improved Marx circuit
- the new unique Haefely Δ -structure is modular (pat. pending) allowing easy upgrading and on-site erection
- easy operation with micro-processor control system
- equipped with resistors for performing lightning and switching impulse voltages (SI resistors are optional)
- ingenious extensions of load range
- short reconfiguration times (handy plug-in resistors and connections, special resistor support)
- the liquid insulation used in the impulse capacitors is made of castor oil which offers optimal environmental compatibility (no PCB's)
- new protective safety grounding device operating automatically at power outages
- compact mobile design with large castors

SG Δ A



Impulse Voltage Test System
SG Δ A 1100-55, 1100 kV, 55 kJ



QUALITY

Haefely Test AG quality assurance complies with DIN ISO 9001.



USER BENEFITS

Quality

Haefely Test AG quality assurance complies with DIN ISO 9001.

Design and manufacturing of our impulse test systems take full advantage of seven decades of experience in high voltage test technology.

Electronic measurement and control systems are designed and manufactured in-house. We have many years of experience with EMC testing as well as an excellent reputation in the field of high voltage test products.

As a result, we achieve high reliability at a favourable price performance ratio.

Safety of Operation

The design of the test system and, in particular, the control system comply with VDE 0104.

Testing personnel benefit from optimal protection against accidents. Especially the newly designed grounding system which is unique. This system, guarantees safe operation under any circumstances, and is automatically activated during a power outage.

As always safe operation of a HV test system does require proper personnel training.

Ease of Operation with Modern Control System

The generator control systems allows very easy and flexible control of the SG Δ impulse test system.

All relevant safety actions are implemented in the hardware independent of any software. Components of the control system are fully EMC tested.

To meet the above requirements our control systems are designed and manufactured by Haefely Test AG, Switzerland

Protection of Test Object and System

The test system automatically shut down if over-voltage, over-current, and/or fast voltage transients occur.

Voltage and current trips can be set individually according to your requirements.

This allows an optimal protection for your specific test arrangements.

The Haefely Δ -Structure Design

The new Haefely Δ -Structure (pat. pending), is modular in design. This modular concept offers the following benefits.

- Fast, easy and safe assembling/disassembling
- A modular expandable system that grows with your application needs
- High stability and durability
- Easy handling and transportation for on-site testing

The impulse test system SG Δ is unique in its kind. It is the result of intensive research and our years of experience in manufacturing high voltage test equipment.

Appearance

High voltage testing is an important part of the manufacturing process which finally ensures the quality of your products.

A well-equipped test hall with appropriate appearance is therefore important. Haefely products are not only technically but also aesthetically designed to complement the quality image of your facilities.



Control Unit
GC 223



Grounding Device

GENERAL SYSTEM SPECIFICATIONS

SGΔA SYSTEM DATA (5 kJ per stage)

Generator				lightning impulse 1.2/50		switching impulse 250/2500 (Option)		Time between impulses at $U_{I \max}$ t
Code	Max. charging voltage	Max energy	Impulse capaci- tance	Max. load	Max. output voltage at $C_{b \max}$ $\pm U_{\text{peak LI}}$	Max. load	Max. output voltage at $C_{b \max}$ $\pm U_{\text{peak SI}}$	
	$U_{I \max}$	W	C_s	$C_{b \max \text{ LI}}$	$\pm U_{\text{peak LI}}$	$C_{b \max \text{ SI}}$	$\pm U_{\text{peak SI}}$	
	kV	KJ	nF	nF	kV	nF	kV	
SGΔA 600-30	600	30	167	6.2	540	1.7	460	40
SGΔA 700-35	700	35	143	5.6	630	1.7	535	40
SGΔA 800-40	800	40	125	5.3	700	2.3	605	40
SGΔA 1000-50	1000	50	100	5.7	870	1.9	695	40
SGΔA 1200-60	1200	60	83	4.7	1040	1.8	790	40
SGΔA 1400-70	1400	70	71	4.0	1250	3.5	1140	40
SGΔA 1600-80	1600	80	62.5	3.4	1420	3.0	1300	45
SGΔA 1800-90	1800	90	55.5	3.0	1600	2.7	1465	50
SGΔA 2000-100	2000	100	50	2.6	1780	2.7	1630	55
SGΔA 2200-110	2200	110	45.5	2.4	1950	2.5	1785	60
SGΔA 2400-120	2400	120	41.7	2.1	2130	1.7	1950	65
SGΔA 2600-130	2600	130	38.5	1.9	2310	1.9	2250	70

Impulse Voltage Test System SGDA 1400-70,
proposed layout

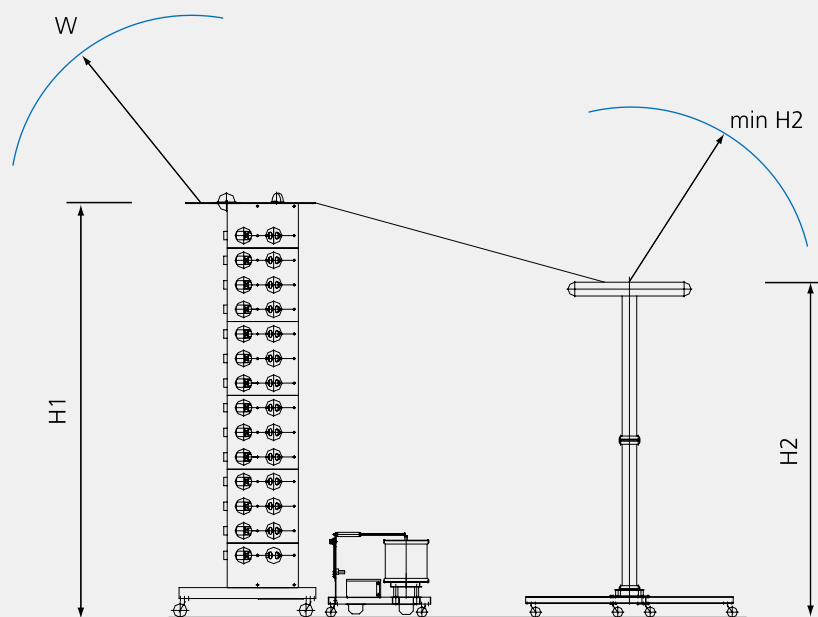

lightning impulse			Divider					Shipping volume/ weight (whole system)
Min. safe clearance to wall	Height	Weight (net)	Code	Capacitance	Damping resistor	Height	Weight (net)	
W	H1			C	R	H2		
m	m	kg		pF	Ω	m	kg	m ³ /kg
1.2	3.4	1300	CS 600-500	500	270	2.3	110	approx. 6 m ³ + 1 m ³ /stage approx. 150% of net weights
1.4	3.7	1375	CS 700-500	500	270	2.4	110	
1.6	4.1	1460	CS 800-670	670	230	3.6	135	
2.0	4.8	1650	CS 1000-670	670	230	3.6	135	
2.4	5.5	1850	CR 1200-700	700	180	3.7	360	
2.8	6.2	2000	CR 1400-525	525	240	5.5	450	
3.2	6.9	2200	CR 1600-525	525	240	5.5	450	
3.6	7.7	2350	CR 1800-420	420	300	6.8	620	
4.0	8.4	2500	CR 2000-420	420	300	6.8	620	
4.4	9.1	2700	CR 2200-350	350	360	7.8	670	
4.8	9.8	2850	CR 2400-350	350	360	7.8	670	
5.2	10.6	3050	CR 2600-300	300	420	8.9	750	

Proposed layout, top view

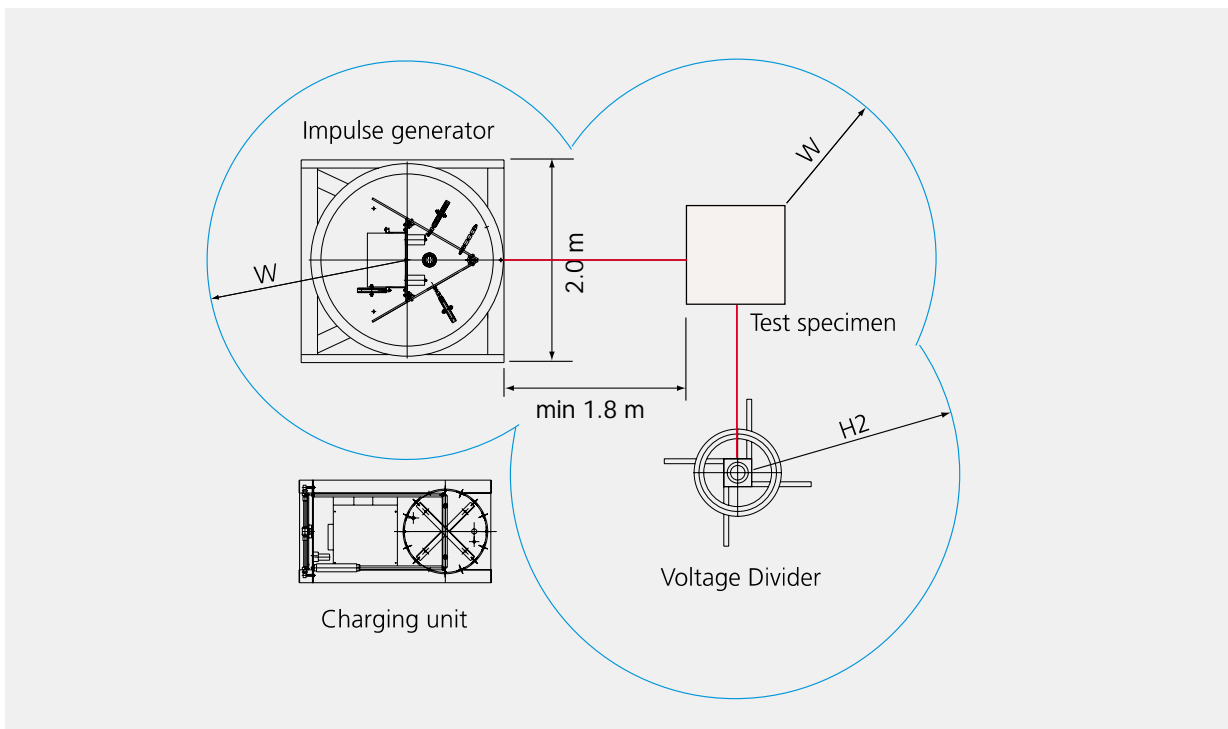

GENERAL SYSTEM SPECIFICATIONS

SGΔA SYSTEM DATA (10 kJ per stage)

Generator				lightning impulse 1.2/50		switching impulse 250/2500 (Option)		Time between impulses at $U_{I \max}$ t
Code	Max. charging voltage	Max energy	Impulse capaci- tance	Max. load	Max. output voltage at $C_{b \max}$ $\pm U_{\text{peak LI}}$	Max. load	Max. output voltage at $C_{b \max}$ $\pm U_{\text{peak SI}}$	
	$U_{I \max}$	W	C_s	$C_{b \max \text{ LI}}$	$\pm U_{\text{peak LI}}$	$C_{b \max \text{ SI}}$	$\pm U_{\text{peak SI}}$	
	kV	kJ	nF	nF	kV	nF	kV	
SGΔA 600-60	600	60	367	6.0	555	1.6	540	40
SGΔA 700-70	700	70	286	5.4	650	1.6	635	40
SGΔA 800-80	800	80	250	5.1	720	2.2	715	40
SGΔA 1000-100	1000	100	200	5.5	900	1.8	825	50
SGΔA 1200-120	1200	120	167	4.5	1070	1.7	930	65
SGΔA 1400-140	1400	140	143	3.8	1290	2.1	1230	70
SGΔA 1600-160	1600	160	125	3.3	1460	1.8	1400	85
SGΔA 1800-180	1800	180	111	2.9	1650	1.8	1600	100
SGΔA 2000-200	2000	200	100	2.5	1835	2.2	1780	110
SGΔA 2200-220	2200	220	91	2.3	2010	1.6	1950	120
SGΔA 2400-240	2400	240	83	2.0	2200	1.6	2135	130
SGΔA 2600-260	2600	260	77	1.8	2380	1.7	2300	140

Clearances and divider types are the same as for 5 kJ per stage generator

SGΔA

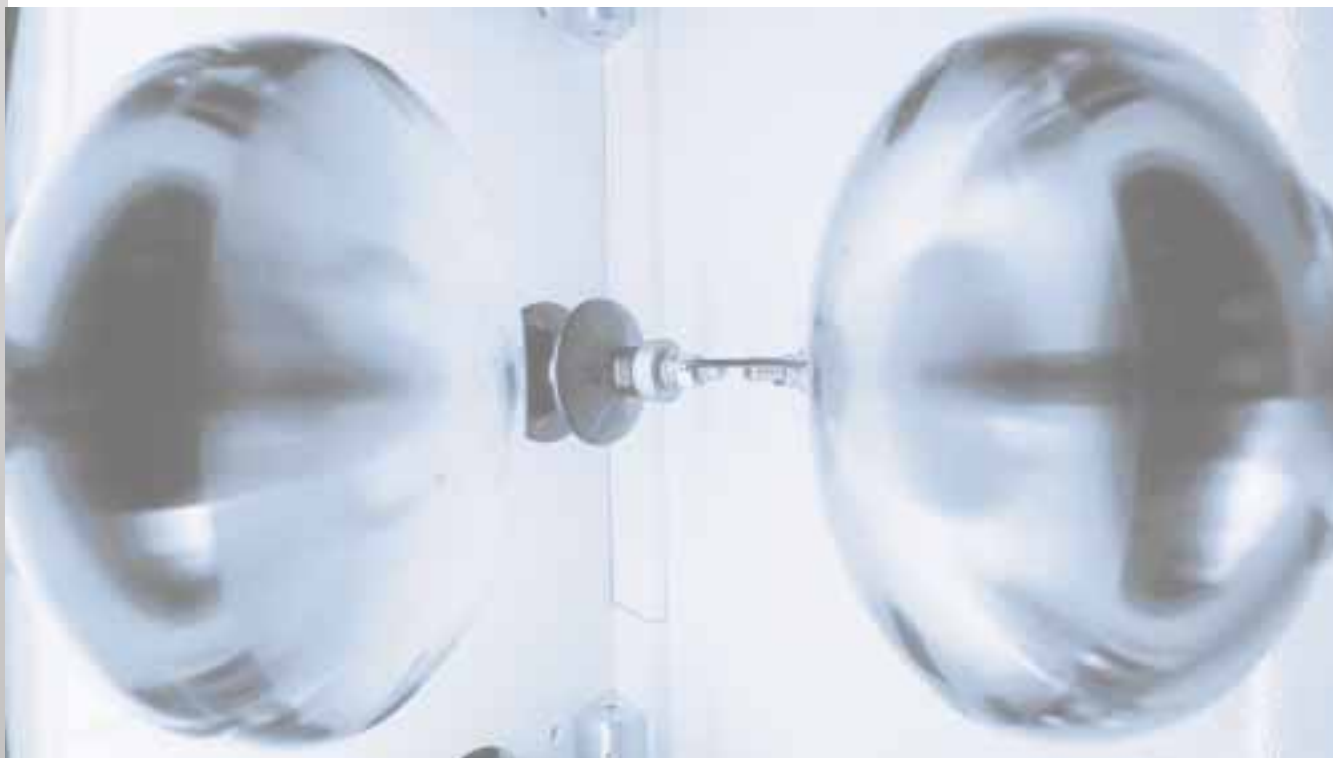

Operating Range

The minimum output voltage is 10 kV independent of polarity. This is obtained with only one stage operating. The other stages are shorted or connected in parallel.

Maximum output voltage can be read from the table on page 6. It depends on the load and the waveform.

The chart shows the influence of front resistor values regarding front time T_f and load capacitance C_b . The calculation is made for an impulse generator type 1200-60 for lightning impulse. Each resistor covers a part of the load range for a front time according standard.

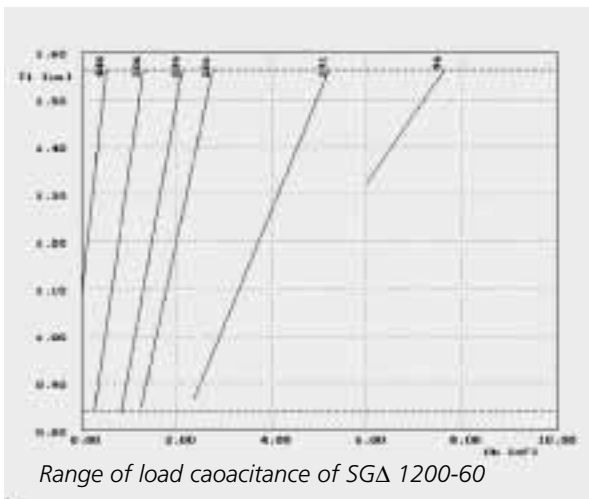

Ambient Conditions

The impulse generator can be operated at ambient temperatures between 3°C and 45°C and relative humidity (r.h.) ≤ 95% (non condensing).

The control and measurement equipment is designed for operation at ambient temperatures of 10°C to 45°C and r.h. values between 35% and 80%.

The permissible temperature and r.h. ranges for shipping and storage of all parts are -20°C to 60°C and ≤ 95% r.h. (non condensing).

The voltage values stated in the documentation are for standard conditions, $T = 20^\circ\text{C}$, $p = 1013 \text{ hPa}$ and $r.h. = 80\%$.

These values apply for operation of the system up to 1000 m above sea level. For higher elevations, the voltage reduces by 1% for each add. 100 m.

Impulse Intervals

At maximum charging voltage, minimum time between impulses is specified in the table system data. This interval is dictated by the maximum charging current and the maximum energy of the impulse capacitors as well as the thermal behaviour of the resistors.

If the charging voltage is reduced, the interval between impulses can be shortened.

Immunity to Electromagnetic Interference

Electromagnetic interference is unavoidable in impulse testing. The SGΔ test system is specially designed to minimise interferences and ensure proper performance of control and measuring electronics.

The measurement signal from the Haefely high voltage divider is in range of 100 V to 1600 V in order to ensure a high signal/noise ratio.

All measurement and control lines are properly shielded and grounded. Inputs and outputs are protected against overvoltages.

System components are prepared for proper grounding with large copper braid or foil for safer operation.

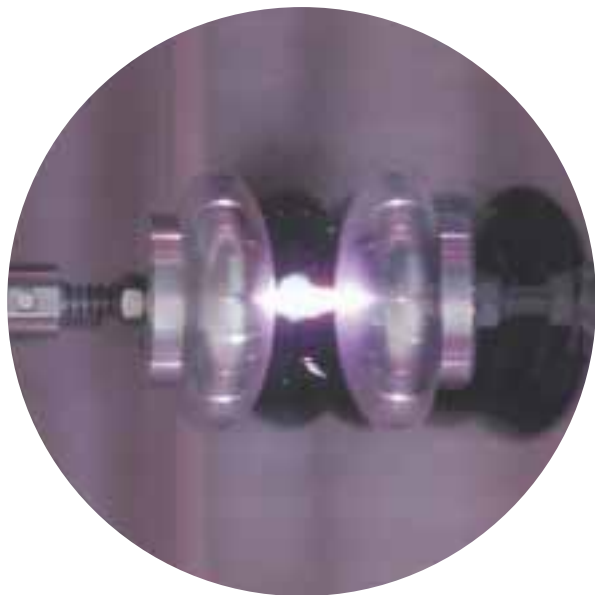

THE IMPULSE VOLTAGE SYSTEM

FUNCTION OF THE IMPULSE TEST SYSTEM

As shown in the block diagram below the test system has the following main components:

- charging rectifier
- impulse generator
- control system
- divider

Accessories for additional measurements, tests or analyses of the wave shape are:

- shunt
- chopping gap
- measuring system

The block diagram below demonstrates the basic functions of the system.

The impulse test system operates under a control system which charges the impulse generator through the charging unit. This is achieved as the stages in the impulse generator are connected in parallel via the charging resistors. Charging time and charging voltage can be selected.

Once the selected charging voltage has been reached, a trigger pulse initiates firing of the first spark-gap of the impulse generator. The resulting overvoltages trigger successive stages. As all the spark-gaps fire, the stages are connected in series thus multiplying the charging voltage.

An impulse voltage divider reduces the impulse voltage to a value that the measuring and recording instruments require.

Impulse Test System

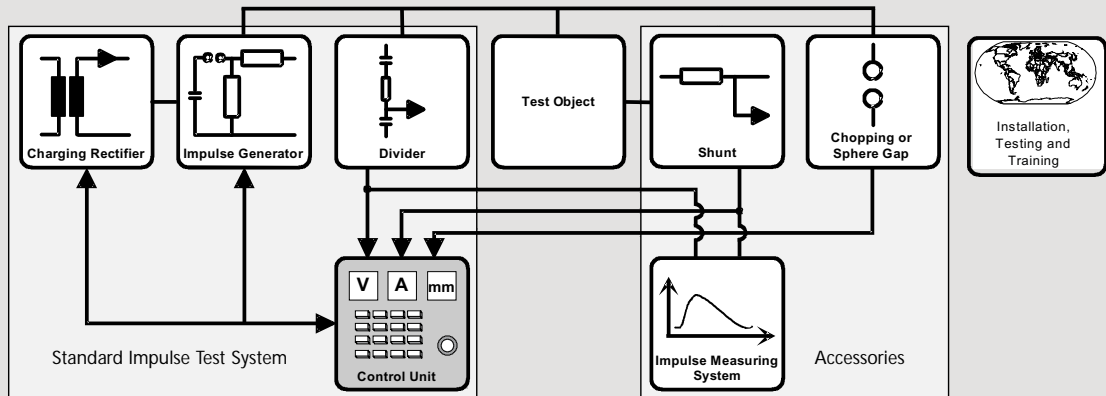

IMPULSE GENERATOR

The Impulse Voltage Generator is the main part of an impulse voltage test system. An impulse voltage generator SGΔ is a number of capacitors charged in parallel up to a maximum voltage of 100 kV. When the final charging voltage is reached, the encapsulated sphere gaps are fired and connect the capacitors in series. Wave shape of the generated impulse is mainly defined by serial and parallel resistors.

The figure shows a simplified equivalent circuit diagram of a one stage impulse generator.

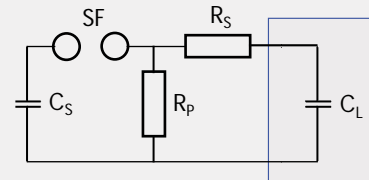

- C_S Impulse Capacitance
- SF Spark Gap
- R_P Parallel Resistance
- R_S Series Resistance
- C_L Load Test Object

DESIGN

Like all Haefely impulse generators the SG Δ generator is based on the MARX multiplier circuit.

Standard impulse generators type SG Δ are equipped with castors for mobility or without castors for stationary operation. Optionally we offer air cushions for easiest moving of very large systems.

The sophisticated design of this impulse test system considers all requirements in conjunction with impulse voltage tests as required by industry (HV- Cable, HV- Power- Transformers, etc.) and universities respectively utilities.

Haefely Δ Structure

The new unique Haefely Δ -Structure (pat. pending) is easy to transport and reassemble, due to its modular design. The sturdiness of the design makes it ideal for on-site testing. Modules of 2 and 3 stages can be combined to any total number of stages between 4 and 26. As shown in the picture below the area enclosed by the inductance loop has been reduced to the minimum (a Δ) which results in minimal inductance in the impulse generator circuit. This has a positive effect on the overall load range, the triggering and the rise times. In order to increase the impulse capacitance, the generator



stages can be grouped and connected in parallel. For larger generators several identical groups can again be connected in series. The total voltage is the product of the stage charging voltage and the number of groups in series. All possible combinations cover requirements for a variety of test loads.



THE IMPULSE VOLTAGE GENERATOR

SGAA

Impulse capacitors

Each impulse capacitor consists of flat elements built into a steel housing and impregnated with castor oil. The housing walls are flexible so that the oil can expand. Years of experience with castor oil guarantee a long capacitor life.

Castor oil offers optimal environmental compatibility (no PCB's).

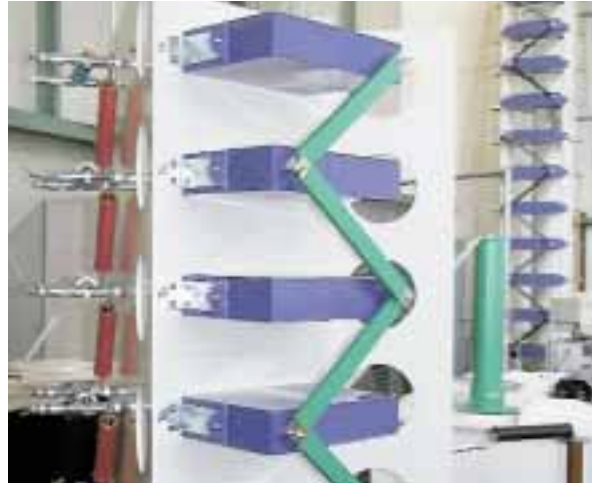

Resistors

Wave shaping resistors built into the impulse generator are wire wound on tubes and protected with shrink tubing against mechanical damage. Each resistor value has a specific colour for easy identification.



These resistors are handy plug-in types for easy and quick reconfiguration. The total number of plug-in positions for serial and parallel resistors is four. This allows more variation possibilities and, due to twin resistors, higher energies and shorter times between impulses.

External series resistors are only required for generators up to 12 stages.

The basic system includes a set of resistors for lightning impulse voltages.



OPTIONS

HAEFELY SAFETY GROUNDING SYSTEM

The new Haefely safety grounding system consists of 3 direct drives and 3 spring loaded reels. No complex gear boxes, no redirection wheels and no adjustments are required which greatly improves reliability. As safety issues are always important, Haefely has developed a safety grounding system which works automatically at power outages.

The new Haefely safety grounding system, which is standard for all SGΔA Generators, provides optimal protection for your operating staff.

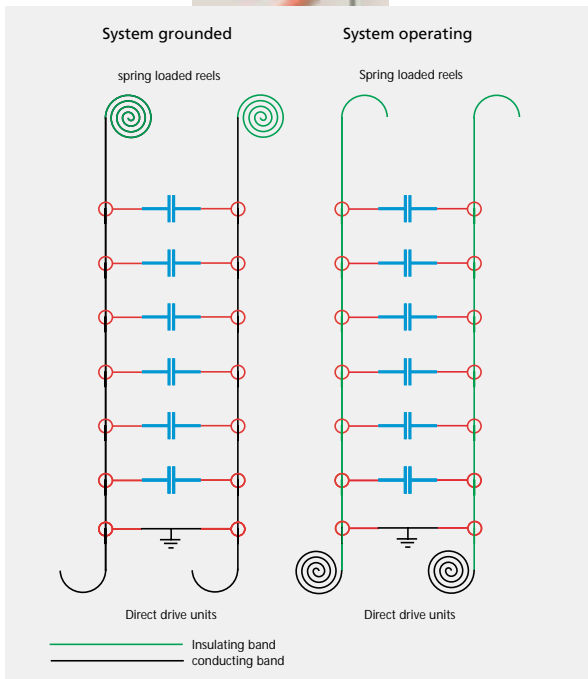

Resistor set for switching impulse

Resistor sets are available for generating 250/2500 μ s switching impulse as defined in IEC 60060-1 and IEEE Std. 4. Resistor sets are available according to IEC 60076-3 and ANSI/IEEE C57.12 for special switching impulse tests of transformers.

Parallel resistors

In order to compensate for the shorter decay time with small inductances, an additional set of parallel resistors can be supplied. It consists of additional two resistors per stage.

Shunts

Haefely shunts are used for the measurement of impulse currents. They consist of a metal cylinder with coupling flanges and coaxial measuring connector.

Different sets of shunts are available.



Top Electrodes

All SGΔA generators are equipped with a large rounded top plate sufficient for many applications. For higher voltages and switching impulses additional top electrodes might be required.

The SGΔA generator is prepared for various top electrode solutions. The top plate allows also mounting of large state electrodes.

Rain Hood for Outdoor Operation

A plastic hood to cover the generator and charging unit is available for temporary protection against rain during on-site service. The hood is rolled up when the system is in operation.

OVERSHOOT COMPENSATION

Application

The patented Haefely Overshoot Compensation is used for lightning impulse voltage tests on high capacitive loads, low inductive loads and impulse test with steep front impulse shapes. Overshoot compensation can be of assistance during dielectric tests of the following equipment:

1. Distribution and Power Transformers (high capacitance / low inductance)
2. Motors / Generators (steep front)
3. Switchgear / Gas insulated Switchgear (high capacitance)
4. Bushings (high capacitance)

Overshoot

Test objects are not pure capacitive loads. A realistic impulse voltage test circuit can be described by the following diagram:

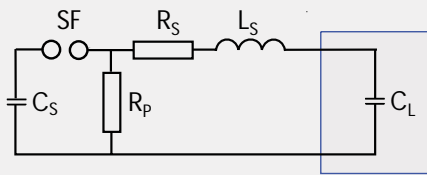

- C_S Impulse Capacitance
- SF Spark Gap
- R_P Parallel Resistance
- R_S, L_S Series Resistance/Inductance
- C_L Test Object, Divider, MAFS (Load)

Compared to a circuit with pure capacitive load (C_L) the real test object (R_L, C_L and L_L) often creates wave shapes with significant oscillation / overshoot.

IEC 60060-1 specifies a maximum of 5% overshoot for lightning impulses.

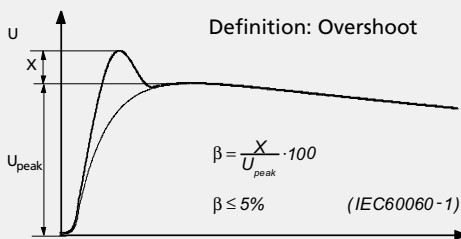

As inductance of the test circuit cannot be reduced (physical laws apply), an additional circuit, the Haefely patented Overshoot Compensation, control can be used to this.

Overshoot Compensation

The Haefely Patented Overshoot Compensation consists of a compensating capacitor (C_C), a compensating resistor (R_C) and an inductance (L_C). This circuit together with the load capacitance C_b forms a first order low pass filter (see diagram below). The high frequencies of an oscillation are damped. Therefore an overshoot can be eliminated or damped.

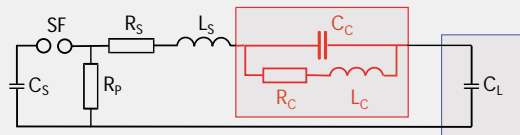

- C_S Impulse Capacitance
- SF Spark Gap
- R_P Parallel Resistance
- R_S, L_S Serie Resistance/Inductance
- C_C, R_C, L_C Overshoot Compensation
- C_L Test Object, Divider, MAFS (Load)

In the following figure the uncompensated voltage (black curve), the voltage across the overshoot compensation (red curve) and the resulting voltage across the test object (blue curve) are shown. The final voltage across the test object is now according to the standard.

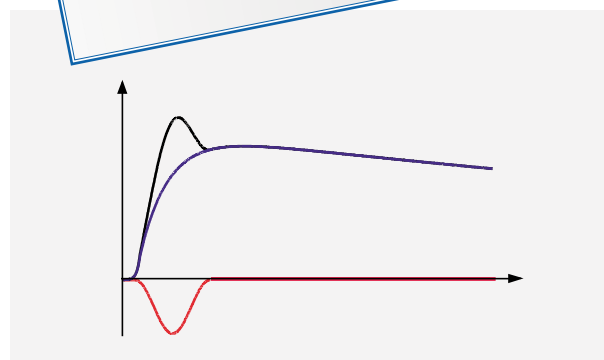
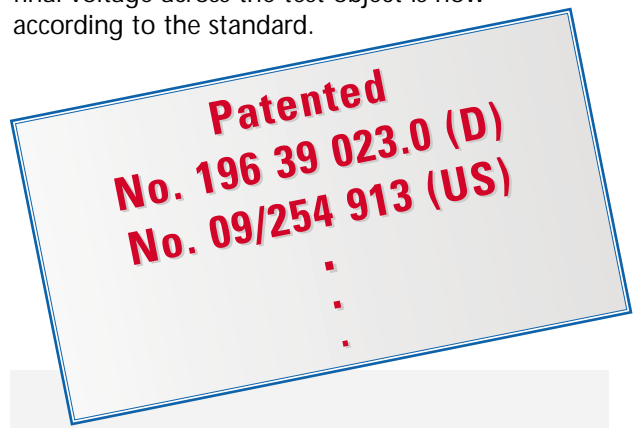

GLANINGER CIRCUIT



External Overshoot Compensation

Advantages / User Benefits

1. Haefely Overshoot Compensation increases the capacitive load range.
2. increases the inductive load range.
3. reduces the oscillation of standard impulse voltages.
4. reduces the oscillation of steep front impulse voltages.
5. Existing systems can be upgraded

Design

An external design for the SG Δ is available. This solution can also be used for "Non Haefely-Generators".

Glaninger

The Glaninger Circuit (see diagram below) can be used for testing very small inductances, such as low-voltage windings of transformers. The Glaninger inductance (L_G) is connected in parallel to the generator serial resistor. The rapid rise at the impulse front (high frequency components) is not influenced by the additional Glaninger inductance L_G , therefore the front of the impulse is mainly defined by the serial resistor. Conversely, the slow decay (low frequency components) at the tail of the impulse is influenced by the parallel connection of L_G and R_S . The result is less damping in the overall test circuit and an increased time to half value.

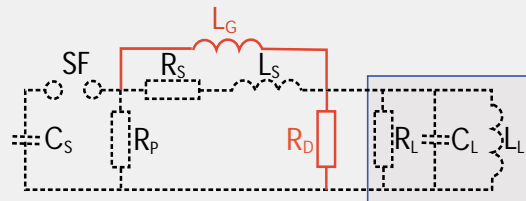

C_S	Impulse Capacitance
SF	Spark Gap
R_P	Parallel Resistance
R_S, L_S	Series Resistance/Inductance
L_G	Glaninger Inductance
R_D	Damping Resistor (only if $L_S < 10 \cdot L_G$)
R_L, C_L, L_L	Test Object, Divider, MAFS (Load)

CHARGING UNIT LGR 100

Charging rectifiers type LGR 100 are used to charge the capacitive storage elements of an impulse generator with stage voltages up to 100 kV such as the generator type SGΔ.

It is usually located close to the base frame of the impulse generator. Connection to the impulse generator is by an aluminium tube. The high voltage transformer is resin or oil insulated, and the rectifier element and measuring resistor are air insulated.

Normally charging rectifiers of this type have castors for mobility.

Standard charging rectifier type LGR 100 has a rated voltage of 100 kV and a current of 20 mA (LGR 100-20) or 40 mA (LGR 100-40).

For generators with more than 12 stages we recommend the 40 mA version.

Main features of the LGR 100 are:

- compact design
- short circuit protected
- standard automatic motor-driven polarity reversal for LGR 100-40
- optional automatic motor-driven polarity reversal for LGR 100-20



LGR 100-40



LGR 100-20

	LGR 100-20	LGR 100-40
Rated voltage U_n , both polarities	100 kV	100 kV
Rated current at U_n , continuous duty	20 mA	40 mA
Circuit	voltage doubling circuit	single-phase one-way circuit
Reversal time for polarity motor drive	approx. 30 s	approx. 30 s
Test voltage, 5 minutes, both polarities	110 kV	110 kV
Ambient temperature	0°C...+45 °C	0°C...+45 °C
Measuring resistor	100 kV, approx. 200 MΩ	100 kV, approx. 200 MΩ
Supply voltage (standard) 3P + N	3x400 V, 50/60 Hz	3x400 V, 50/60 Hz
(For earth trip breaker protected supply voltages matching transformer required)		
Power consumption	4 kVA	10 kVA
Input power three phase (also valid for matching transformer design)	10 kVA	22 kVA
Weight (approx.) net	165 kg	540 kg
gross	240 kg	700 kg
Shipping volume	1.5 m ³	2.5 m ³

DIVIDERS

CS/CR - DAMPED CAPACITIVE IMPULSE VOLTAGE DIVIDER

Damped capacitive impulse voltage dividers are used to measure high voltage full and tail chopped lightning and full switching impulses. Provided with an adequate additional secondary part they can also be used for alternating voltage measurements.

Dividers of type CS and CR also represent a basic load capacitance for the impulse generator.

Insulating cylinders house oil/paper capacitor packs. Damping resistors for dividers of type CS are placed externally on top of the uppermost capacitor. Dividers of type CR have an internal distributed resistance and, for higher voltages, an external damping resistance.

Main features:

- response of system meets the requirements of IEC 6006-2 (1994)
- stable four arms mobile base frame
- indoor and outdoor types available
- different top-electrodes available depending of switching impulse requirements



CR-3200-263

CONTROLS

Two control systems different in sophistication/technical data are available from Haefely. The competitive and well established GC 223 and the fully computerised GC 96 IMP.

Control systems for the SGΔA test system allow creation of fully automatic test sequences. Programming of the control system is user-friendly and easy. A manual mode is also available. Data communication between other Haefely equipment (impulse measuring equipment) is fully supported. So the control system determines automatically the efficiency factor of the impulse test system in a specific test configuration from the measured impulse amplitude of a single pulse. For all following shots, the charging voltage is automatically controlled in such a way, that a preset output voltage is met exactly. Remote control from a host computer is also available.

The control system can be designed as a desk, a mini rack or an integrated version. Haefely control systems are based on an in-house design of PCI (special computer based on the latest P.C.). No additional measures such as optical link or IR communications are necessary.

Impulse Generator Control GC 223

- comfortable and flexible control of an impulse system
- safety actions implemented in hardware, independent of any software
- manual and automatic mode available
- digital measuring system (eg. HiAS 743) can be easily integrated
- stand alone or 19" rack insert available
- dust and dirt protected
- RS 232 Interface
- automatic correction for atmospheric conditions
- EMC shielded and proofed
- execution of automatic test sequences (optional)
- remote control of all functions (optional)
- control of external chopping gap (optional)

Advanced Impulse Generator Control GC 96 IMP

The basic functions are the same as in the GC 223, but GC 96 IMP offers more operating and upgrade capabilities.

- sophisticated sequence programs
- user-friendly software developed in co-operation with industry
- equipped with a VGA colour monitor. The operator is prompted by the software.
- easy and clear indications and graphical display of several features, such as: -trip levels, -system status, -failure conditions, -flashovers, etc.
- desk or console version available
- permits free programming and storage of complex test cycles. Any number of test cycles can be stored.
- including interfaces for remote control and for transfer of measured data.
- fully automatic operation mode for customised test sequences with individual parameters (optional)
- can be upgraded with integrated measurement and control functions as required.

Safety and Protection Functions

The control unit has a connection for a safety circuit and is equipped with a connection for warning lights. Actuation complies with VDE 0104. The lockable emergency switch is built into a separate box. The switch can be placed as needed so that it can be operated quickly in case of emergency. All safety functions are directly wired to the input circuit breaker i.e. they do not pass through the micro-processor control system.

OPTIONS

Control Desk

The control unit GC 96 IMP can be mounted in different desk or console versions. Unused space in the control desk can be used for other measurement instruments, such as the Haefely HiAS, DiAS or DMI.

GC 96 IMP Interface

With a GC 96 IMP serial interface, the test system can be controlled by a higher-level computer. The interface is optically isolated, so that electromagnetic compatibility standards (IEC 61000-4-2) are completely fulfilled.

SPECIAL SOLUTIONS

Mobility

The basic version of the SG Δ is equipped with a rigid base frame and large castors. As an option we offer air cushions.

On-site testing

Due to the new modular Haefely Δ -Structure (pat. pending) assembly of the generator is performed extremely fast. A 2000 kV generator consists of 6 modules, base and topframe. To set up such a system :

- the modules have to be placed on top of each other
- a few resistors and drive shafts have to be plugged in
- the three grounding bands must be mounted

These tasks can be performed much faster than for any other generator currently available. All Haefely SG Δ generators are based on this new structure enabling easy erection as well as upgrading.

Test system for oscillating lightning and switching impulses, SG Δ A-L

IEC 60517 requires that gas-insulated switchgear (GIS) must be tested once the on-site installation is completed. The following tests are recommended:

- Oscillating lightning impulse (OLI), max. rise time 15 μ s
- Oscillating switching impulse (OSI), rise time 150 μ s to 10 ms

SG Δ A-L impulse test system is supplied with the following additions:

- Resistor set for switching impulse
- Inductance modules for generating OLI
- Inductance modules for generating OSI

The oscillation frequency is essentially determined by the inductance of the coils and the capacitance of the test object. In addition to the voltage divider, a capacitive load of 2 nF is required for operation of the test system.

The inductors are modular, designed to match the rated voltage of the generator. Each module consists of a wire coil wound on an insulating tube.

The inductances are arranged horizontally between generator and divider.

An advantage of aperiodic impulse voltages is the



smaller and thus lighter impulse generator (e.g. a 600 kV - generator can generate oscillating switching impulses of approx. 1000 kV peak). The impulse generator can be shipped as assembled modules, base and top frame, which reduces the set-up time to a minimum.

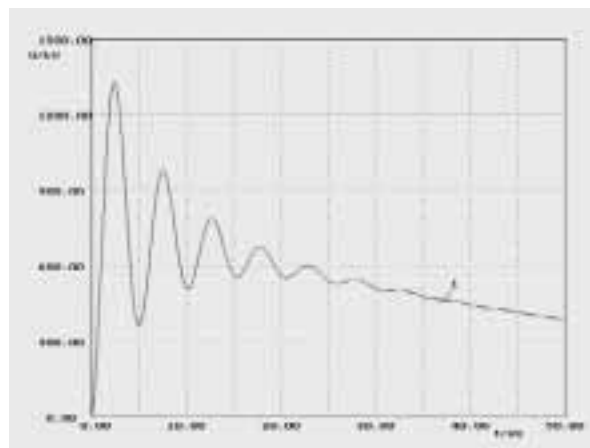

OSCILLATING IMPULSE TEST SYSTEM

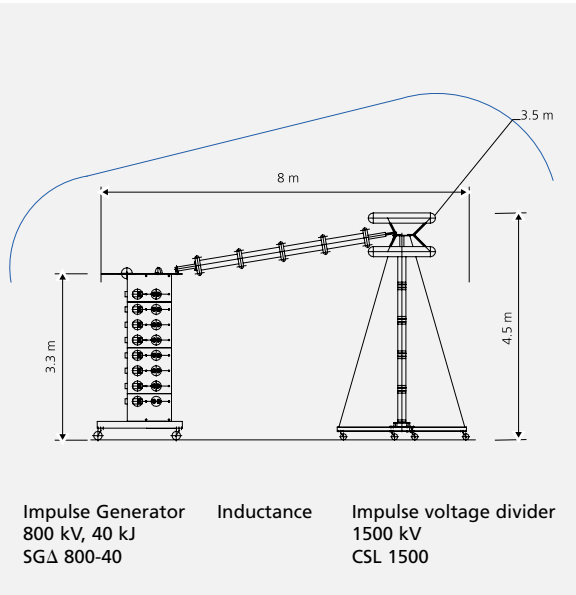

Impulse test system SGΔ A-L 1400-70 for oscillating switching impulse

Specification SGΔA-L

Specification SGΔA-L		Oscillating lightning impulse-OLI					Oscillating switching impulse -OSI				Divider	Dimension of test location			
Code	Load without divider nF	Number of inductance modules	Peak value (kV)		Rise time T1 (μs)		Number of inductance modules	Peak value (kV)		Peak time Td (μs)			L	W	H
			2nF	20nF	2nF	20nF		2nF	20nF	2nF	20nF				
SGΔA-L-600-30	2-20	3	1000	800	5	12	3	950	750	140	350	CSL 1200	11	8	7
SGΔA-L-800-40	2-20	4	1400	1150	5	13	4	1350	1000	150	360	CSL 1500	14	11	9
SGΔA-L-1800-90	2-20	7	3100	2200	5	13	5	2800	1900	160	400	CR 3200	26	20	18

Impulse Current

Theoretically only different resistors and wave shaping inductances are required for the generation of impulse currents.

In practice it is necessary to know the required wave shape, the relevant standard, the residual voltage (in the case of arrester testing) and the maximum load capacitance. With this information a possible extension of an impulse voltage generator to an impulse current generator can be estimated.

For lightning impulse current 8/20 μs according IEC 60060-1 and 60099-4 an extension is usually possible.



Technical Services

A high level of customer service is essential in view of the complexity of high voltage test systems and the high reliability demanded by the customer.

The full warranty of the impulse voltage test system is conditional on the performance of the following Haefely services being performed:

- Expert installation and on-site testing of the system
- Training of the operating personnel
- Maintenance of the test system throughout its service life, but for a period of at least 10 years
- Availability of spare parts at least for 10 years

Installation and Testing On Site

The user is responsible for preparation of the test station and the power supply. The installation and connections for the power supply transformers must be prepared.

The warranty of an impulse test system requires that the system must be installed and tested on site under the supervision of Haefely specialists.

Haefely performs fine tuning on the control and measurement electronics.

A system test is then performed under no load conditions.

Acceptance testing is performed in co-operation with the purchaser. If possible, the customer furnishes a test object. It is understood that Haefely does not assume any liability for the test object should it be damaged during the acceptance test.

A standard acceptance test includes the following points:

- Tests of all functions
- Calibration of controls
- Impulse tests

Training of Operating Personnel

After acceptance testing, the personnel assigned to operate the impulse voltage test system will be trained.

Installation and operator training are conducted by Haefely customer service personnel and are adapted to suit the particular test facility and test specimen. This is an important contribution to reliable operation of the test system.

10 Years Maintenance Guarantee

A large stock of replacement parts is held for maintenance purposes. This makes it possible for Haefely to ensure maintenance for 10 years from the purchase date.

On-Site Calibration Service

Simple and unified calibration methods which apply to complete measuring systems give high-voltage test equipment manufacturers, users and customers the assurance of comparable quality requirements and tests involving such equipment.

Haefely performs following services:

- Calibration of divider
- Calibration of measuring unit
- Calibration of entire system

Other Services

Haefely offers a maintenance agreement tailored to the customer's special needs. In this way, the value of the test system can be preserved over a long period of time.

Further services are offered for support in integration tasks or during operation.

SCOPE OF SUPPLY

SGΔA

- 1 Impulse generator 1.2/50 μ s, including:
 - Mobile base frame
 - Enclosed spark gaps
 - Motor driven safety grounding system
- 1 Set resistors for lightning impulse
- 1 Charging rectifier, 100 kV, 20 mA with manual polarity change or 40 mA with automatic polarity change for generator with 10 kJ per stage
- 1 Control unit GC 223
 - 2 Control cables, each 20 m
- 1 Impulse voltage divider CS ___ or CR___mobile
 - 1 Secondary unit
 - 1 Measuring cable, 20 m
- 1 Grounding rod
 - with grounding wire, 5 m
- 1 Copper grounding band, 30 m
- 2 Set of operating instructions with test report (in English or German)
- 1 Technical service (upon request)
 - Installation and testing on site
 - Training of operating personnel

SGΔA-L same as above, plus:

- 1 Impulse voltage divider CSL ___ or CR ___ (instead of CS)
- 1 Set resistors for switching impulse
- 1 Inductance for OLI
- 1 Inductance for OSI

Options

- Sphere gap KFS
- Multiple chopping gap MAFS
- Set resistors for switching impulse SGΔ SW
- Set resistors for testing of small inductance SGΔ RP
- Glaninger circuit for very small inductance SGΔ WI
- Set of terminal resistors for winding transformers tests SGΔ TERM
- Charging rectifier 100 kV, 40 mA LGR 100-40, instead of LGR 100-20
- Motor drive for polarity reversal LGR POL (for 20 mA LGR only)
- Insulating and matching transformer SGΔ TRANS
- Overshoot Compensation for high capacitive loads SGΔ OC
- Set of spare parts SGΔ ERS consisting of:
 - impulse Capacitor
 - resistor of each value and type
 - trigger electrode for spark-gap



E117.10

Subject to change
without prior notice
09.2001

Haefely Test AG
High Voltage Test Division

Lehenmattstrasse 353. P.O. Box
CH-4052 Basel
Switzerland

www.haefely.com

Phone: +41.61. 373 41 11
Fax: +41.61. 373 49 12
e-mail: sales@haefely.com

HAEFELY 
HIGH VOLTAGE TEST